

## M1326 SERIES

AC/DC POWER SUPPLY



### PRODUCT HIGHLIGHTS

- RUGGED, FIELD DEPLOYABLE
- FREE AIR CONVECTION COOLED
- SINGLE OUTPUT
- HIGH POWER FACTOR
- SINGLE-PHASE AC/DC POWER SUPPLY
- UP TO 1000 W

## Applications

Military (Airborne, ground-mobile, ground-fix, shipboard), Telecom, Industrial Rugged Power Supply

## Special Features

- Convection cooled
- Extremely rugged
- Universal input range
- Input / Output isolation
- High Power Factor
- Internal EMI filters
- Remote sense option
- Remote Inhibit option
- Inrush current limiter
- Fixed switching freq. (250 kHz)
- Non-latching protections:
  - Input under-voltage lockout
  - Short-circuit/overload
  - Output over-voltage
  - Over temperature

## Electrical Specifications

### AC Input

single-phase  
85 to 265V<sub>AC</sub> / 50 to 400Hz  
Operates from a 115 V<sub>AC</sub> / 400 Hz source IAW MIL-STD-704E

### Output Voltage Regulation

Up to ±1%  
(no load to full load, –40 to +71 °C, over normal input voltage range).

### Ripple and Noise \*

Up to 1% of output voltage without external capacitance.  
(Values are usually much lower - depends on output voltage).

### DC Output\*

Voltage range: 3.3 to 300 V<sub>DC</sub>  
Current range: 0 to 80 A  
Power range: 0 to 1 000 W

### Efficiency

85% ± 2% typical  
(nominal input voltage, 28V output, full load, room temperature)

### Isolation

Input to Output: 1 000 V<sub>DC</sub>  
Input to Case: 1 000 V<sub>DC</sub>  
Output to Case: 200 V<sub>DC</sub>

### EMC

Designed to meet MIL-STD-461G<sup>†</sup>:  
CE101, CE102, CS101, CS114, CS115, CS116, RE101, RE102, RS101, RS103

### Turn-On Transient

No voltage overshoot during power-on.

- \* Actual maximum power depends on ambient temperature – see specific variant definition.
- † Compliance achieved with a shielded harness and static resistive load.
- \* Measured on load or on output pins, with probe positioned right across a 1µF X7R capacitor.

**Protections \*\***

**Input**

- **Inrush Current Limiter**
- **Catastrophic Failure Protection**  
Internal fuses included to protect the system from a catastrophic failure within the power supply. The fuses are rated not to engage due to any combination of normal operation conditions.
- **Under-Voltage Lock-Out**  
The converter may shut down to protect itself in case input voltage falls below  $75 V_{AC} \pm 5 V_{AC}$ .

**Output**

- **Over-Voltage Protection**
  - Active circuit shuts output down in case output voltage exceeds  $110\% \pm 5\%$  of nominal voltage. Automatic recovery when output voltage returns to normal range.
  - Passive protection (transorb) at output, selected  $20\% \pm 10\%$  above nominal voltage.
- **Overload / Short Circuit**  
Output shuts down and restarts periodically (hiccup) in case output current exceeds maximum current by  $20\% \pm 10\%$  until fault removed.

**General**

- **Over Temperature Protection**  
Shutdown if internal baseplate temp. exceeds  $+105\text{ }^{\circ}\text{C} \pm 5\text{ }^{\circ}\text{C}$ . Automatic recovery upon cool down to below  $+95\text{ }^{\circ}\text{C} \pm 5\text{ }^{\circ}\text{C}$

**Environmental Conditions**

Designed to Meet MIL-STD-810G

**Ambient Temperature**

Methods 501.5 & 502.5  
Operating<sup>‡</sup>:  $-40\text{ }^{\circ}\text{C}$  to  $+71\text{ }^{\circ}\text{C}$  (see derating curve)  
Storage:  $-55\text{ }^{\circ}\text{C}$  to  $+125\text{ }^{\circ}\text{C}$

**Humidity**

Method 507.5  
Up to 95% RH

**Rain**

Method 506.5, Procedure I (Rain and blowing rain)  
Rainfall rate: 0.846 mm/min (2 in/hr)  
Wind velocity: 30 knots, with up to 60 knots gusts  
Exposure duration: one hour

**Altitude**

Method 500.5  
Procedure I (Storage/Air transport): up to 40 000 ft.  
Procedure II (Operation/Air Carriage): up to 15 000 ft.

**Salt Fog**

Method 509.5

**Sand and Dust**

Method 510.5  
Procedure I (Blowing dust)  
Procedure II (Blowing sand)

**Ingress Protection**

IP-67 option available – *consult factory for details.*

**Vibration**

Method 514.6, Procedure I  
Category 24 – General minimum integrity exposure

**Shock**

Method 516.6, Procedure I  
20 g / 11 ms terminal peak sawtooth shock pulse

**Reliability**

150,000 hours, calculated IAW MIL-HDBK-217F Notice 2 at +45 °C ambient, Ground Fix environment.

---

\*\* Thresholds and protections can be modified / removed – **please consult factory.**

## General Architecture

The M1326 accepts universal AC input voltage between 85 to 265 V<sub>AC</sub>, 50 to 400 Hz and generates an isolated, well-regulated and protected DC voltage.

The unit is built from the following blocks:

1. Input stage, which includes an input AC power switch, input current protection and EMI filter (lightning protection **optional** – *consult factory for more information*).
2. High power factor AC/DC converter
3. Auxiliary converter for housekeeping voltages.
4. Isolated DC/DC converter.

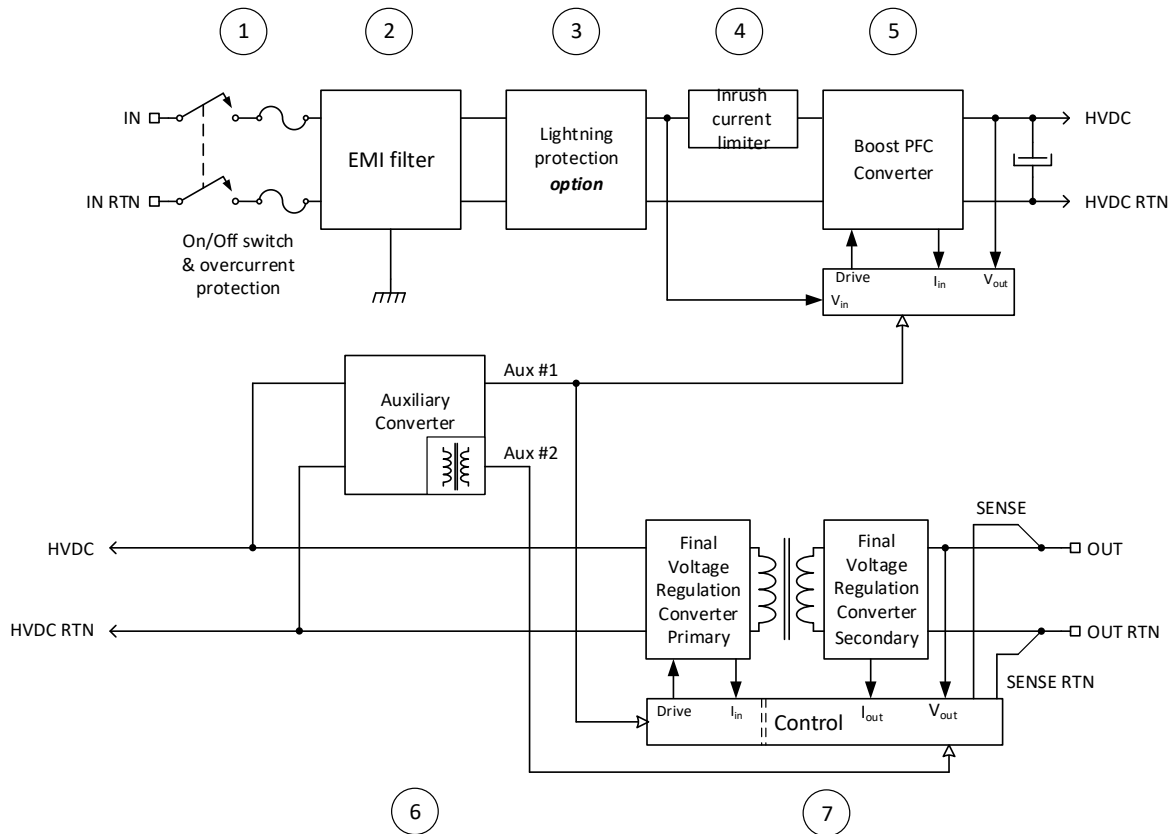

## **1. Input stage, EMI filter and protections**

The input stage is composed of an AC on/off switch and an over-current protection mechanism, followed by an EMI filter that includes MOV surge arrestors (for low power spikes only). Lightning protection option available – see more information below).

- 1 The **AC switch** allows an easy and simple disconnection of the power supply from the input AC line.

Fuses/weak-links are used as means of protection against shorted input stage components. The only scenario that may result in an open fuse is a catastrophic failure of the unit, which requires the replacement of the input AC/DC stage.

- 2 The **EMI filter** is designed to meet MIL-STD-461G CE102 conducted emissions limits. Since the unit is enclosed within a six-wall aluminum chassis, the entire assembly forms a Faraday cage configuration that attenuates the radiated emission from the unit to well below the MIL-STD-461G RE102 radiated emissions limits. High-frequency filters (differential and common-mode) on the input and on each of the outputs attenuate the conducted high frequency emission of unit's I/Os, allowing the host system (with the aid of shielding around the cables) to successfully pass the system-level radiated emission test. The same filters and shielded enclosure also reduce the susceptibility of the unit to external radiation and conducted interference (MIL-STD-461G CS101, CS114, CS115, CS116 and RS103).

- 3 A **lightning protection** circuit can be included as an option, to protect the power supply from repetitive fast transients and bursts IAW EN61000-4-4, and from lightning, IAW EN61000-4-5. Depending on the specific configuration, the addition of this circuit may increase the power supply's size. *Consult factory for more information.*

## 2. High power factor AC/DC converter with inrush current limiter

The AC/DC converter converts the AC input (85 to 265V at 50 to 400Hz) to a semi-regulated, non-isolated high voltage (400V). This stage comprises two sub-stages:

④ The **inrush current limiter** circuit limits the initial charge-up current of the inter-stage bulk capacitance.

⑤ The **high power factor AC/DC converter** shapes the average input current draw, by changing the inter-stage output voltage in synchronization with the momentary input voltage, input current and output current. By doing so, the power supply is able to present a resistor-like load to the generator at nominal conditions.

The advantages of using a power factor correction circuit are numerous. It provides a better utilization of the generator/alternator by not wasting energy for creation of reactive power; it increases overall efficiency; it decreases low frequency distortion; and it provides better utilization of the inter-stage bulk capacitance for attenuation of the input voltage ripple.

The output of the PFC converter is a semi-regulated and protected (i.e. over-current and over-voltage protection) high voltage DC bus.

## 3. Auxiliary converter

⑥ The different stages in the power supply use several housekeeping voltages, generated by a separate converter, feeding off the high voltage DC. This converter generates non-isolated and isolated vol final output voltage is generated by an isolated, well-regulated and protected (from over-current, short-circuit and over-voltage) DC/DC converter.

## 4. Final voltage regulation DC/DC converter

⑦ The final output voltage is generated from the high voltage DC bus by an isolated, well-regulated and protected (from over current, short-circuit and over-voltage) DC/DC converter. The output voltage goes through a final EMI filter before reaching the output connector, to further decrease the output voltage ripple, and assist in radiated emission suppression to meet MIL-STD-461G RE102.

**Power derating curve: Output power vs. ambient temperature**

The power supply is capable of delivering up to 1000W to the load, in perfect conditions. However, when operating in elevated ambient temperature, the power output should be de-rated according to the following curve:

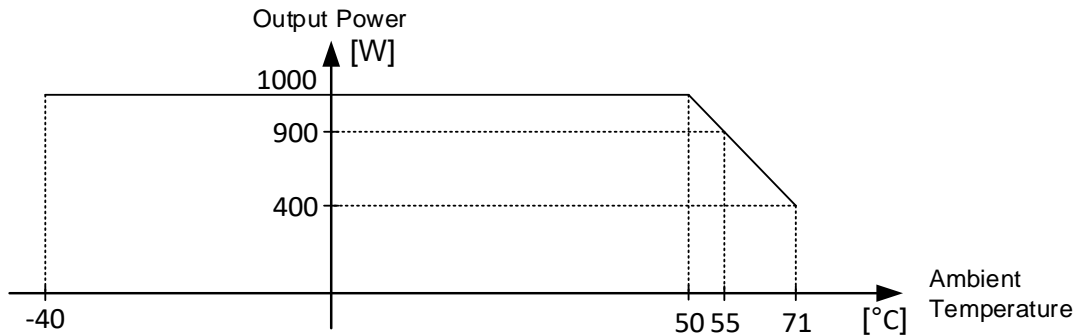

*This curve should be used as a reference only.* The power supply's efficiency is affected by the input voltage, output voltage, output current and switching frequency. Convection efficacy is affected by the ambient temperature, altitude and total available air volume; there can be additional out-of-unit heat that can increase the power supply's temperature via incoming radiation. Consult factory for actual expected values in your application.



### Pin Assignment – Option 1

Input Connector (J1):

**Connector type:** AIB2-20-3PS or eq. with lanyard tied protection cap.

**Mating connector type:** AIB6-20-3SS or eq.

Pin #	Function	
A	LINE	●
B	NEUTRAL	●
C	SAFETY GND	●

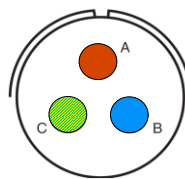

Output Connector (J2):

**Connector type:** MS3470W14-4S or eq. with lanyard tied protection cap.

**Mating connector type:** MS3476W14-4P or eq.

Pin #	Function	P	
A	OUTPUT	+	●
B	OUTPUT RTN	-	●

Pin #	Function	P	
C	OUTPUT	+	●
D	OUTPUT RTN	-	●

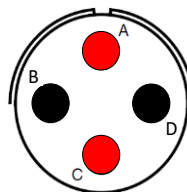

**Note:**

1. Other connector options available – *consult factory*
2. All pins with identical function/designation should be connected together for best performance.
3. In models with no SENSE/SENSE RTN pins, the output voltage is regulated at the OUTPUT/OUTPUT RTN pins. Since no remote sense compensation is available in these cases, some voltage drop across the output harness is to be expected, dependent on the output current and harness wires resistance. Output harness should be designed in accordance.

## Pin Assignment – Option 2

Input Connector (J1):

**Connector type:** GTS030-20-3P-025 or eq. with lanyard tied protection cap.

**Mating connector type:** GTS06-20-3S-025 or eq.

Pin #	Function	
A	LINE	●
B	NEUTRAL	●
C	SAFETY GND	●

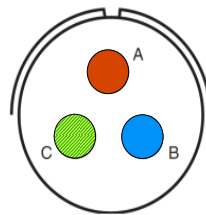

Output Connector (J2):

**Connector type:** MS3112E10-6S or eq. with lanyard tied protection cap.

**Mating connector type:** MS3116E10-6P or eq.

Pin #	Function	P	
A	OUTPUT	+	●
B	OUTPUT	+	●
C	OUTPUT RTN	-	●

Pin #	Function	P	
D	OUTPUT RTN	-	●
E	N/C		
F	N/C		

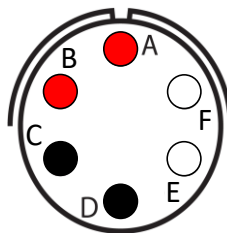

**Note:**

1. Other connector options available – *consult factory*
2. All pins with identical function/designation should be connected together for best performance.
3. In models with no SENSE/SENSE RTN pins, the output voltage is regulated at the OUTPUT/OUTPUT RTN pins. Since no remote sense compensation is available in these cases, some voltage drop across the output harness is to be expected,

dependent on the output current and harness wires resistance. Output harness should be designed in accordance.

### **Functions and Signals**

#### **SAFETY GND** (connector J1, pin C)

This pin is connected internally to the power supply's chassis. Connect this pin to system's safety ground to allow a low resistance ground fault current path.

#### **GND** (chassis thread)

The **GND** thread allows an additional low resistance connection of unit's chassis to system ground, for a visual second safety path for ground fault current.

#### **BIT** (panel mount red LED)

The BIT notifies the user whether the output voltage is within normal range or not. If the LED is on (red light visible), the output voltage is within normal range. If the LED is off, the output voltage is below normal range.

**Optional additional signals** (not available in standard version - *consult factory for details*)

#### **SENSE**

The **SENSE** line is used to achieve accurate voltage regulation at load terminals.

To use this feature, connect this pin directly to load's positive terminal.

If this function is not required, short **SENSE** pin to **OUTPUT** pins as close as possible to the unit.

#### **SENSE RTN**

The **SENSE RTN** line is used to achieve accurate voltage regulation at load terminals.

To use this feature, connect this pin directly to load's negative terminal.

If this function is not required, short **SENSE RTN** pin to **OUTPUT RTN** pins as close as possible to the unit.

Note: The use of remote sense has a limit of voltage dropout between the converter's output and the load's terminals of approximately 5% of nominal output voltage.

#### **INHIBIT**

The **INHIBIT** signal is used to turn the power supply ON and OFF.

TTL "1" or OPEN – Power supply active (output turned on).

TTL "0" or SHORT to Signal RTN – Power supply inhibited (output turned off).

If this function is not required, leave this pin unconnected.

This signal is referenced to **SIGNAL RTN**.

#### **SIGNAL RTN**

**INHIBIT** signal is referenced to this pin.

This pin is floating from both input and output.

**M1326 Series– AC/DC Power Supply**

**Outline Drawing – Option 1**

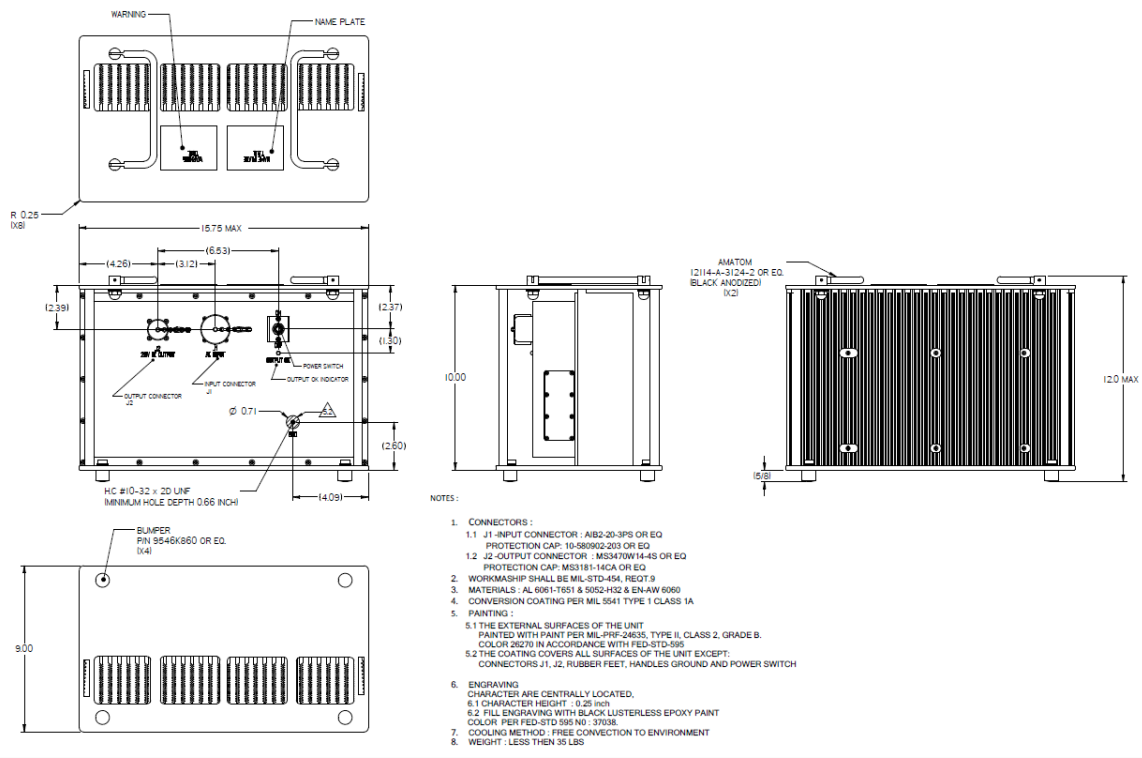

**Note: Specifications are subject to change without prior notice by the manufacturer**

Cham, [www.enercon-europe.com](http://www.enercon-europe.com)  
Switzerland [sales@enercon-europe.com](mailto:sales@enercon-europe.com)

Netanya, [www.enercon.co.il](http://www.enercon.co.il)  
Israel [sales@enercon.co.il](mailto:sales@enercon.co.il)

Gurgaon, [www.mpsindia.in](http://www.mpsindia.in)  
India [sales@mpsindia.in](mailto:sales@mpsindia.in)

**M1326 Series– AC/DC Power Supply**

**Outline Drawing – Option 2**

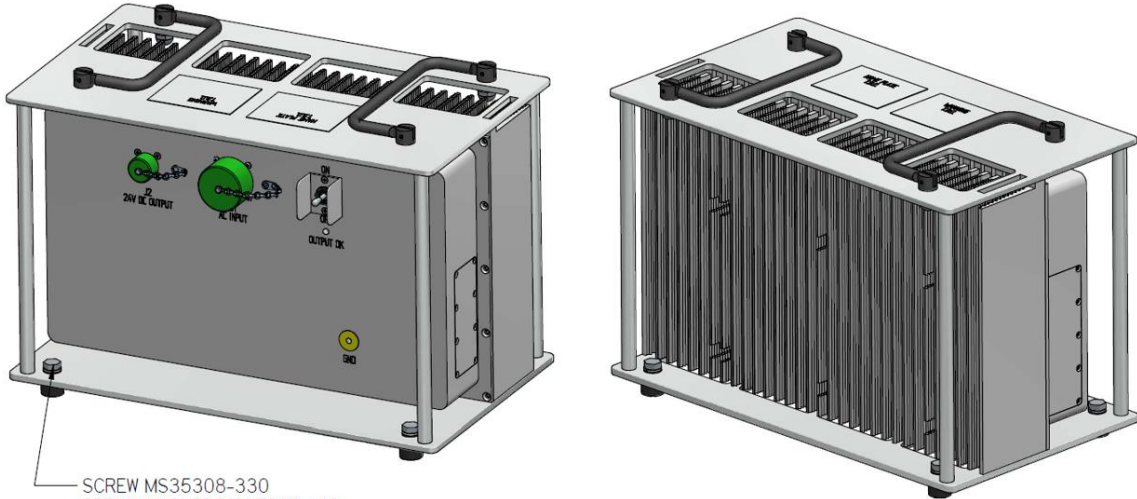

SCREW MS35308-330  
SPRING WASHER MS35338-140  
FLAT WASHER NAS1587-5L  
(X4)

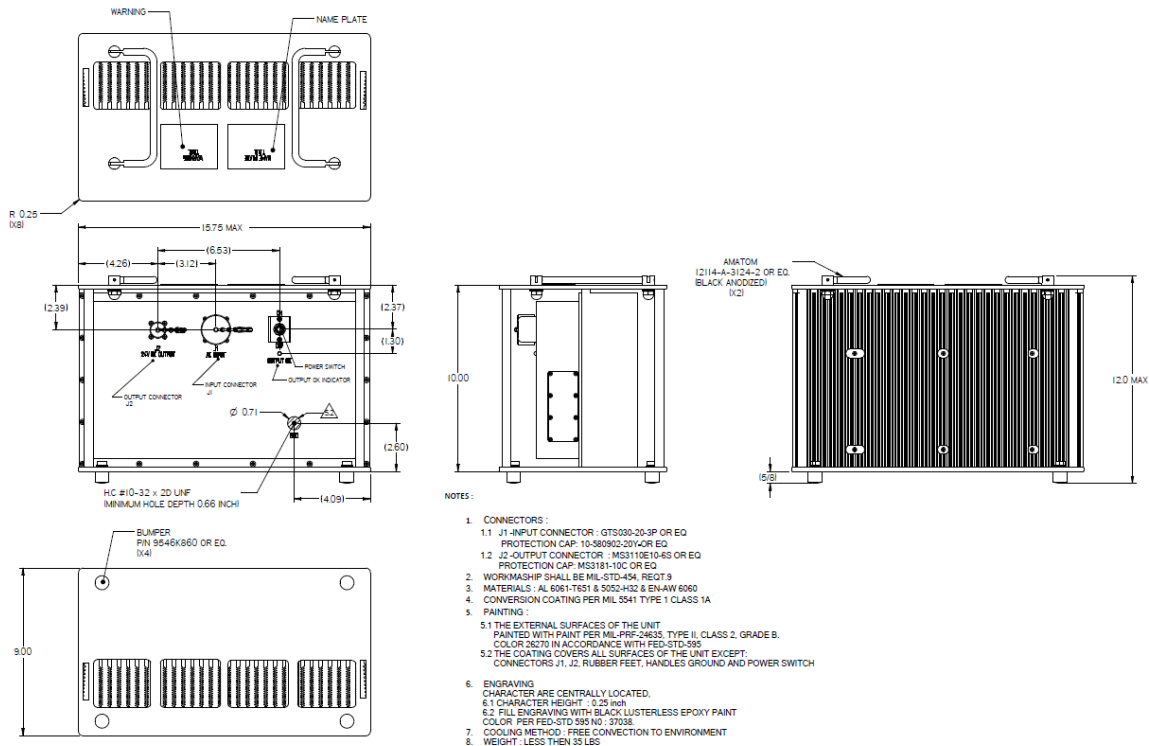

Cham, [www.enercon-europe.com](http://www.enercon-europe.com)  
Switzerland [sales@enercon-europe.com](mailto:sales@enercon-europe.com)

Netanya, [www.enercon.co.il](http://www.enercon.co.il)  
Israel [sales@enercon.co.il](mailto:sales@enercon.co.il)

Gurgaon, [www.mpsindia.in](http://www.mpsindia.in)  
India [sales@mpsindia.in](mailto:sales@mpsindia.in)

**Standard Models List (for other voltages – consult factory)**

Part number	Input		Output		Special features
	Voltage range	Frequency	Voltage	Current	
M1326-103	85-265VAC/Single phase	50/60/400Hz	28 V <sub>DC</sub>	36 A	

- Additional standard configurations available. **Contact factory for more details.**
- All of our products can be configured to comply with EU REACH regulations. **Contact factory for more details.**

***Note: Specifications are subject to change without prior notice by the manufacturer***